

112HTH[™]

Frequency Response & Coverage Graphs - 27 Nov 2018

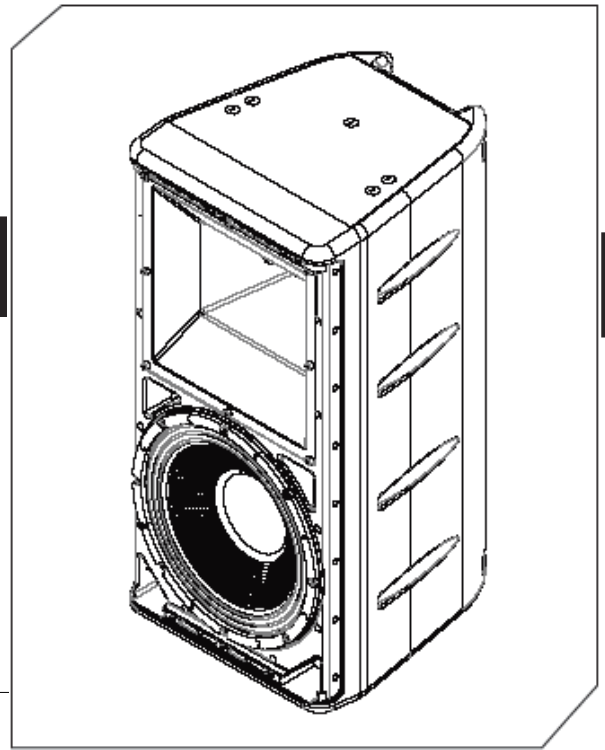

Frequency Response: 112/HTH

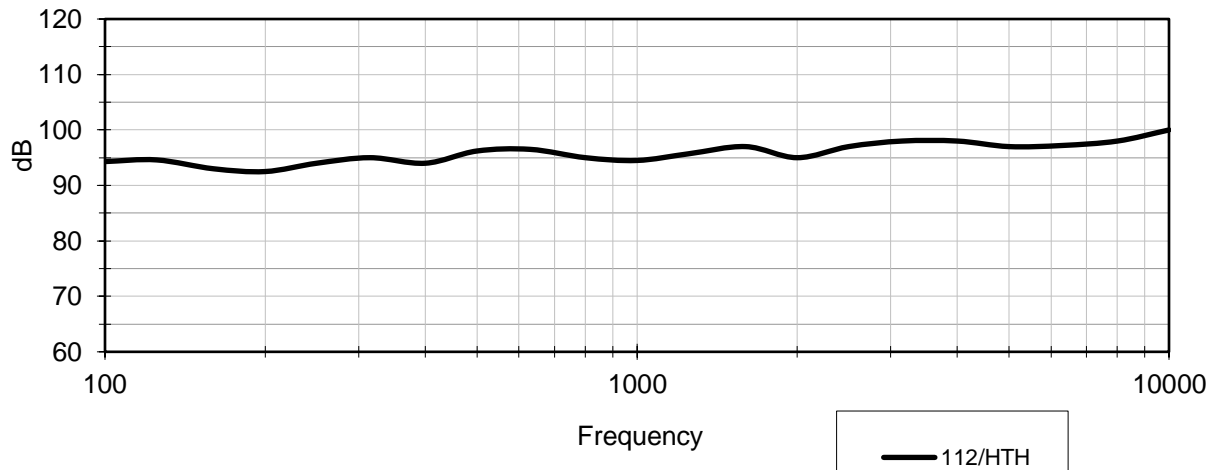

Frequency Response: 112/HTH (105x60)

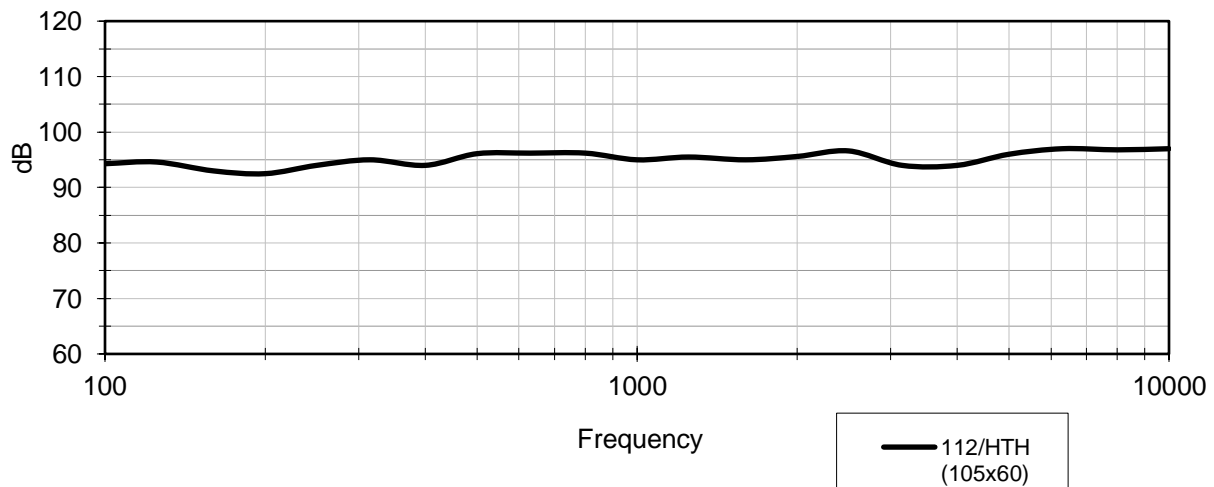

112/HTH @ 6dB down

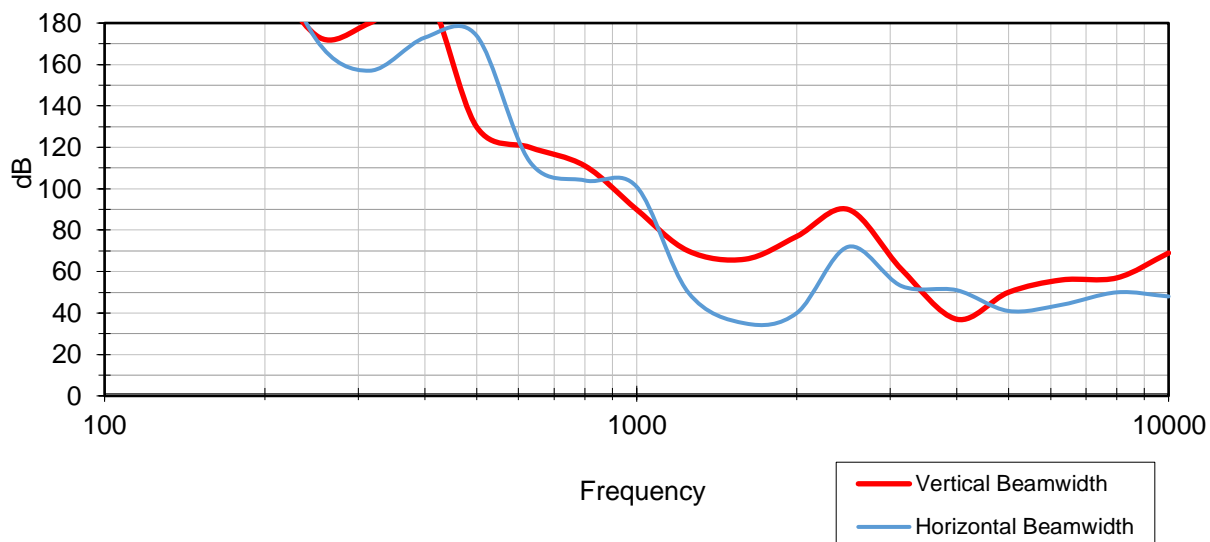

112/HTH (105x60) @ 6dB down

