

108/STC[™]

The One Systems 108/STC is a universal direct weather loudspeaker system designed for use in general purpose inland environments. The 8-inch coaxial design provides true point source acoustic radiation from an extremely compact enclosure. The 108/STC utilizes stainless steel for all rigging points used in conjunction with One Systems rigging accessories, such as the optional PM3/M pole mount bracket, or the PT-38/M pan/tilt bracket. The included U-Bracket and grille are both made from structural steel coating with a highly durable dual layer zinc rich powder coating.

The 108/STC also features a configurable Hi Z or Lo Z mode. The Hi Z mode features a wide bandwidth 150-watt autoformer that presents input taps of 150 watts, 75 watts, and 37.5 watts. The Lo Z mode is 8-ohms. The simple configuration process can be found on the third page of this datasheet, or on the One Systems website (www.onesystems.com). The configuration scheme does not utilize any switches that limit system reliability. The Hi Z mode allows for either 70.7Vrms or 100Vrms operation. The 108/STC offers a small format titanium compression driver and high order filtering that provides superior intelligibility and extended bandwidth. The use of a neodymium compression driver allows the system to be extremely lightweight for efficient installation.

The 108/STC is optimized for outdoor short throw to medium throw applications in theme parks, parade routes, baseball and football stadiums, and other entertainment/sports venues where permanent installation is required. The 108/STC has a very versatile design that offers high performance in a small physical package.



FEATURES & BENEFITS

- » Stainless steel rigging points
- » Dual layer zinc rich powder coat utilized on grille and included U-Bracket
- » Combined 70.7V/100V/Direct operation
- » No performance degrading passive protection devices
- » 150 Watts continuous power handling in direct (8 ohm) operation
- » Highly suitable for inland direct weather environments
- » Optional PM3/M pole mount system and PT38/M pan/tilt bracket available
- » IEC 529 IP 45 ingress protection

SPECIFICATIONS

Frequency Response:	70Hz-20kHz	Size (mm):	350 x 233.2 x 271.4
Coverage Pattern:	70 Conical	(Not including U-Bracket)	
Crossover Frequency:	1.5kHz	Size (Inches):	13.8 x 9.2 x 10.7
System Sensitivity 1w/1m:	89dB	(Not including U-Bracket)	
Power Handling:	150w		
Input Impedance (Lo Z):	8		
Input Taps (Hi Z):	150/75/37.5w		
Weight:	8.4kg, 18.5 lbs		

108/STC[™]

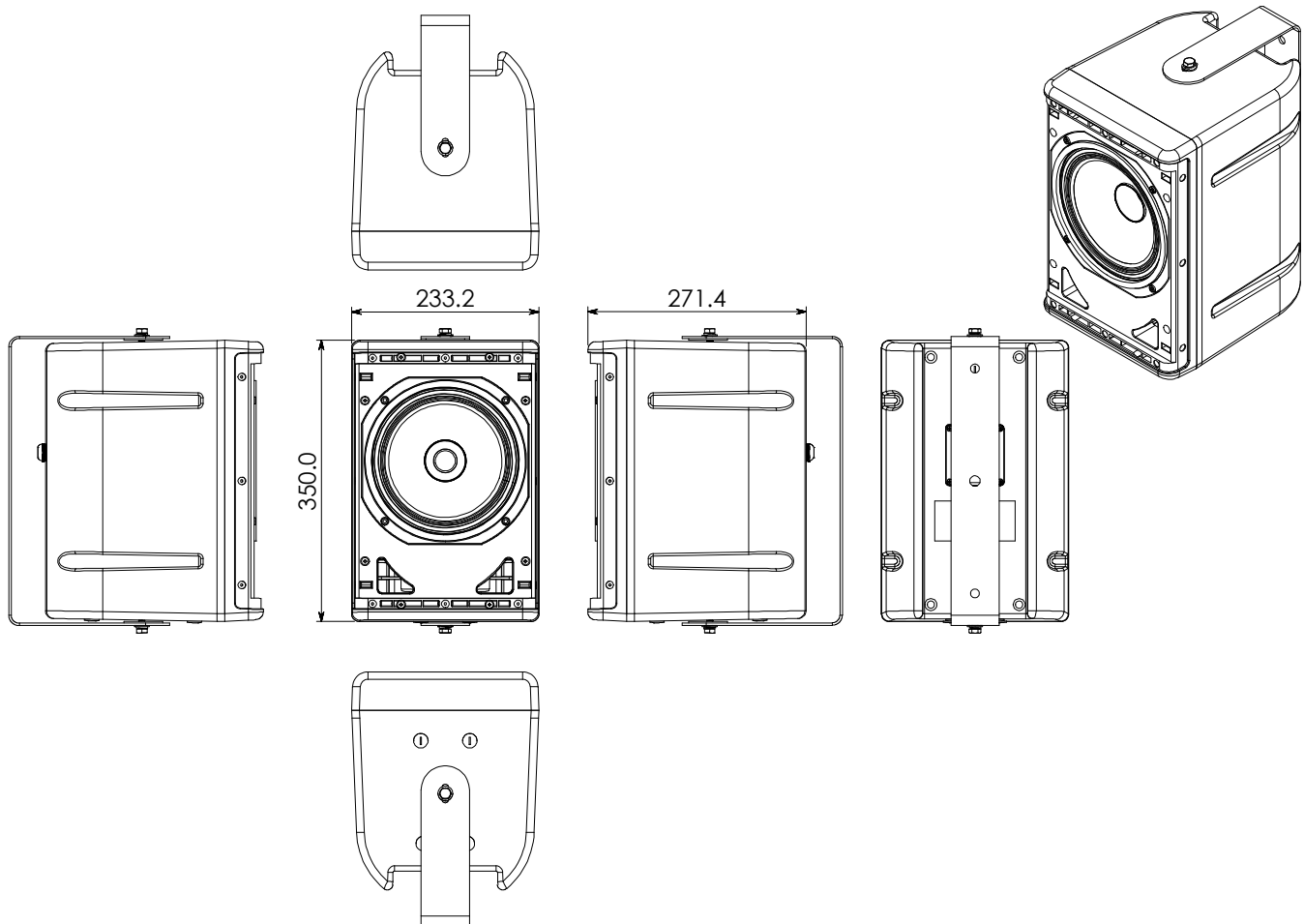

The 108/STC is a two-way speaker featuring a wide coverage pattern of 70 degrees by 70 degrees. The pattern is conical. This medium Q pattern is ideal for short to medium throw applications and also for applications where higher sound pressure levels and longer throws are specified. The high frequency wave guide provides optimal loading for the true compression driver. The 8-inch low frequency component features a very large voice coil diameter, insuring high reliability and excellent linearity. The One Systems 108/STC features 7 M8 rigging points on the enclosure. These rigging points are used with the optional One Systems PM3/M pole mount system or PT38/M rigging brackets. The 108/STC comes with an attached U-Bracket.

The enclosure is an injection molded design that utilizes a high-impact copolymer material that exhibits superior weather resistance. The 108/STC cabinet is available only in grey, which has been stabilized for ultra-violet exposure. The enclosure features a three-layer "rain shield" grille design and an input weather cover with a waterproof gland nut. The system ingress protection is rated at IP 45, configurable to IP 56.

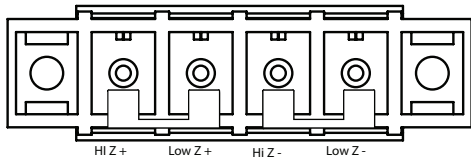

108/STC[™]



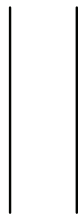
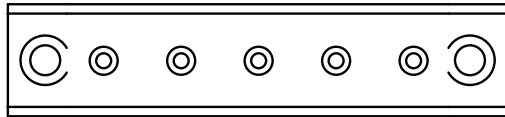

100V		NC	150W	75W	37W
70.7V		150W	75W	37W	NC

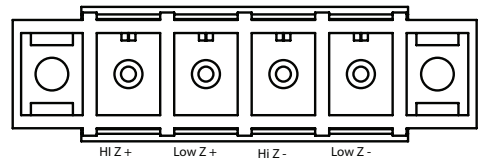

FROM HI Z
AMPLIFIER



100V		NC	150W	75W	37W
70.7V		150W	75W	37W	NC

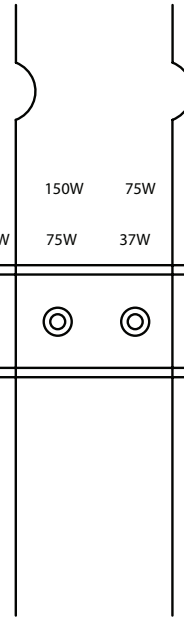
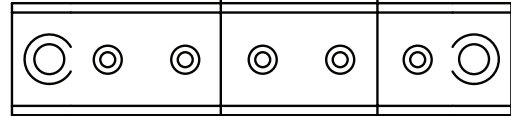

FROM LO Z
AMPLIFIER