

1

108IM™

LIGHTWEIGHT COPOLYMER-BASED ALL-WEATHER LOUDSPEAKER SYSTEM

ONE SYSTEMS®

The One Systems 108IM is a compact, direct-weather 8-inch two-way loudspeaker system with a copolymer enclosure. The 108IM may be used in direct-weather outdoor installations as well as for indoor applications where high vocal intelligibility and musical accuracy are required. The system consists of a single 8-inch (203.2 mm) woofer and One Systems' ETS driver coupled to a fully-rotatable, constant-directivity high-frequency horn.

The 108IM's is optimized for outdoor applications such as football and baseball stadiums and other sports venues where direct weather capability is a requirement. The high-efficiency HF driver and advanced crossover design deliver very high power handling and excellent system reliability without the need for passive protection devices. The 108IM's basic design incorporates a patent-pending high-frequency driver that enables a variety of radiation patterns. The 108IM comes with two horns - the factory-installed horn delivers a medium-Q 60-degree by 40-degree coverage pattern - and the system also includes a 105-degree by 60-degree wide coverage model. Both horns are fully-rotatable for maximum placement flexibility.

The 108IM's patent-pending ETS driver is a unique "equivalent throat" design that allows its radiation pattern to be controlled by the phase plug summation plane instead of the conventional "exit diameter" at the end of the driver's structure. The ETS driver has a titanium diaphragm and a close-spaced circumferential ring phase plug to insure extended high-frequency bandwidth.

The 108IM features 200 watts continuous, 800 watts peak power handling. It is also available with an optional 150-watt, 3-tap line-matching transformer with taps at 150 watts, 75 watts and 37.5 watts. The 108IM -70/100 is factory wired for both 70.7Vrms and 100Vrms operating levels.

The 108IM's enclosure is molded from a special copolymer that is designed to handle high UV exposure and harsh weather environments. All of its internal and external hardware and its grille are made of stainless steel or of high-grade aluminum. The 108IM's grille is a 3-layer "rain shield" design that will minimize direct rain contact with the system's transducers. The unique vent design also allows for easy moisture drainage from the interior of the enclosure. The enclosure and grille are rated to IEC 529 / IP 45 (solid object penetration to 1 mm

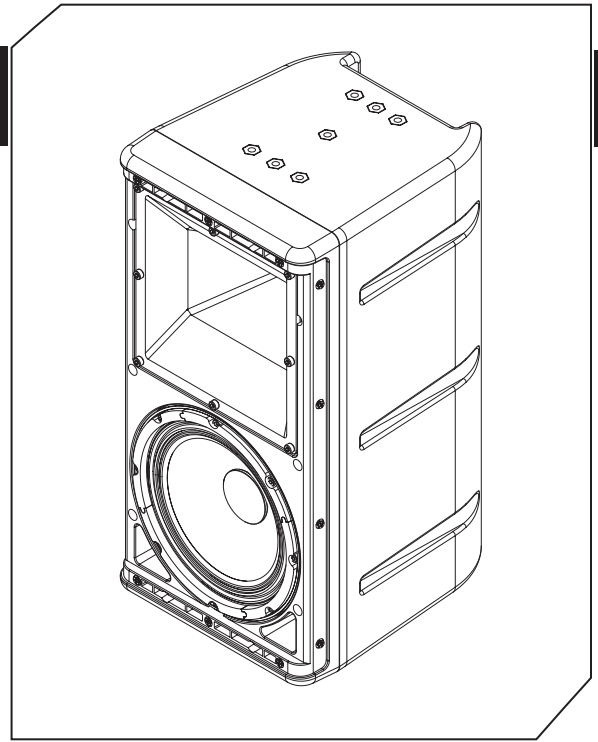

FEATURES & BENEFITS

- » Direct-weather 8-inch two-way system
- » Optimized for high intelligibility, excellent vocal articulation and accurate musical clarity
- » Comes with two interchangeable ETS rotatable high-frequency horns with patent-pending compression driver
- » 8" woofer with large-sized voice coil
- » Available in black or white finish that is easily paintable
- » Available in 8-ohm, 70.7/100-volt versions
- » Optional suspension accessories, pan and tilt and pole mount brackets available

SPECIFICATIONS

Frequency Response:	65 – 16kHz
Coverage Pattern:	105 H x 60V (ETS105/60) 60H x 40V (ETS60/40)
Passive Crossover Freq.:	2,000 Hz (ETS-60x40) 1,600 Hz (ETS-105x60)
Inputs:	5-position barrier strip or 2 x 4-pin Speakon
System Sensitivity (1watt / 1meter):	92 dB
Power Handling:	200 watts continuous, 400 watts program, 800 watts peak*
Nominal Impedance:	8 ohms



108IM™

LIGHTWEIGHT COPOLYMER-BASED ALL-WEATHER LOUDSPEAKER SYSTEM

ONE SYSTEMS®

(0.04 inches) and water jets from any direction). The enclosure and components are also rated to Mil Spec 810

The 108IM's input section features a weather cover with an integral gland nut that is rated to an IP 68 standard. The system's input connectors include a four-position, stainless steel barrier strip and 2 x 4-pin Neutrik Speakons. In outdoor applications, connections are made via the 4-position barrier strip through the gland nut. The gland nut is weatherproof, is rated NEMA 6P (IP 68) and it will accommodate cables with outside diameters from 7 mm to 12 mm (0.236 to 0.472 inch). Its maximum diameter will accommodate most 2-conductor AWG 12 cables.

The 108IM is designed for permanent installation applications and a variety of rigging and suspension options are available. The 108IM has 15 x M8 mounting points.

An M8 forged-shoulder eye bolt kit is available for use in all M8 suspension points. The 108IM may be mounted in selected installations (when permitted by local codes and appropriate substrates) using either a One Systems PT-35-2 pan and tilt bracket or the 108IM-U U-Bracket. All mounting points are made of stainless steel.

SPECIFICATIONS	
Low Frequency:	One Systems 8-inch
High Frequency:	One Systems ETS Driver
Suspension/Mounting points:	15 x M8
Weather Performance:	IEC 529 / IP 45 / Mil Spec 810
Dimensions (H x W x D) mm:	483.84 mm x 243.2mm x 270.77 mm
Dimensions (H x W x D) in:	19.05 in x 9.56 in x 10.66 in
Net Weight:	15 kg (33 lb) 8-ohm 16.5 kg (36.4 lb) trans- former versions
Optional Accessories:	108IM-U "U" bracket kit; PT-35-2 Pan and Tilt bracket; M8 Forged Shoulder Eye Bolt kit; PT-30 (new); PT-38 (new)

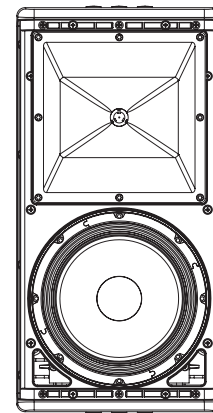
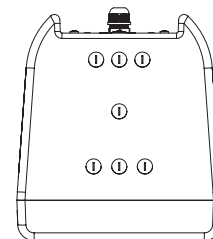
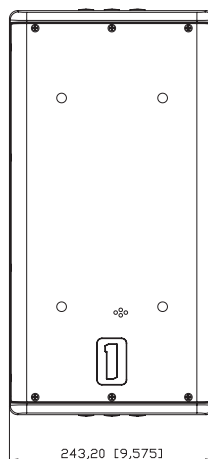
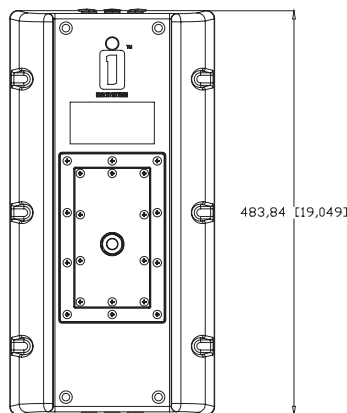
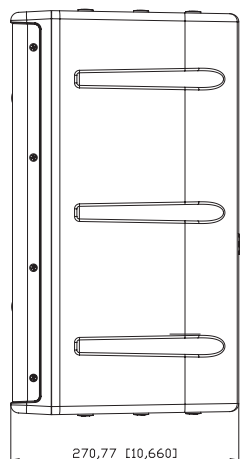



108IM™

Constant Voltage Transformer Wiring

LIGHTWEIGHT COPOLYMER-BASED
ALL-WEATHER LOUDSPEAKER SYSTEM

ONE SYSTEMS®

All ONE SYSTEMS enclosures that feature constant voltage transformers may be wired as shown below. The 108IM-70/100 allows for both 70.7V and 100V wiring. The taps are 150 watts, 75 watts, and 37.5 watts. All wiring is via the five-position barrier strip. The wiring is shown in Table 1.

CAUTION: The weather cover must be installed (even if the enclosure is not installed in an outdoor venue) after the connections to the barrier strip are made. Installation of the weather cover is mandatory and will isolate the high voltages present on the terminal strip from contact.

Figure 1 is a schematic diagram of the transformer wiring for both the 100 volt and 70.7 volt models.

100V Wiring

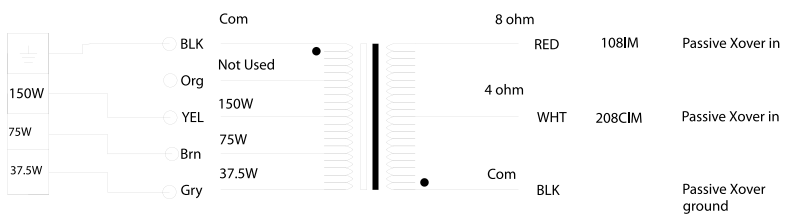

Wire color to barrier strip pin

BLK Org YEL Brn gry

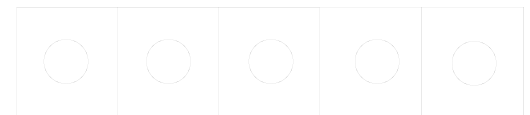

100 V		NC	150 W	75W	37.5W
-------	--	----	-------	-----	-------

70.7V		150 W	75W	37.5W	NC
-------	--	-------	-----	-------	----

70.7V Wiring

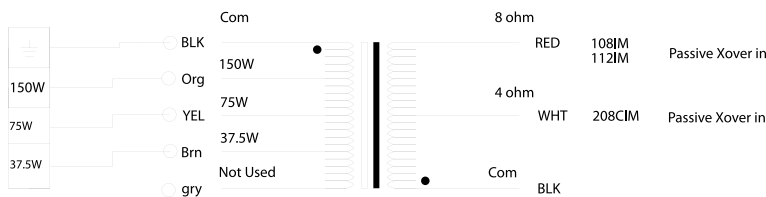

ONE SYSTEMS®

One Systems, Inc • 6204 Gardendale Dr. • Nashville, TN 37215
One Systems Global Co. Ltd. • 87/114 Modern Town 15th Floor • Sukhumvit 63 Ekkamai Soi 3
Klongtoey, Bangkok 10110 Thailand